

**This electronic collection of documents is provided
for the convenience of the user
and is Not a Certified Document –**

**The documents contained herein were originally issued
and sealed by the individuals whose names and license
numbers appear on each page, on the dates appearing
with their signature on that page.**

**This file or an individual page
shall not be considered a certified document.**

6/23/16

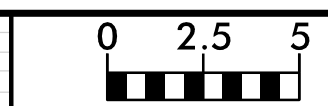

PROJ. REFERENCE NO.	SHEET NO.
48786	X-1

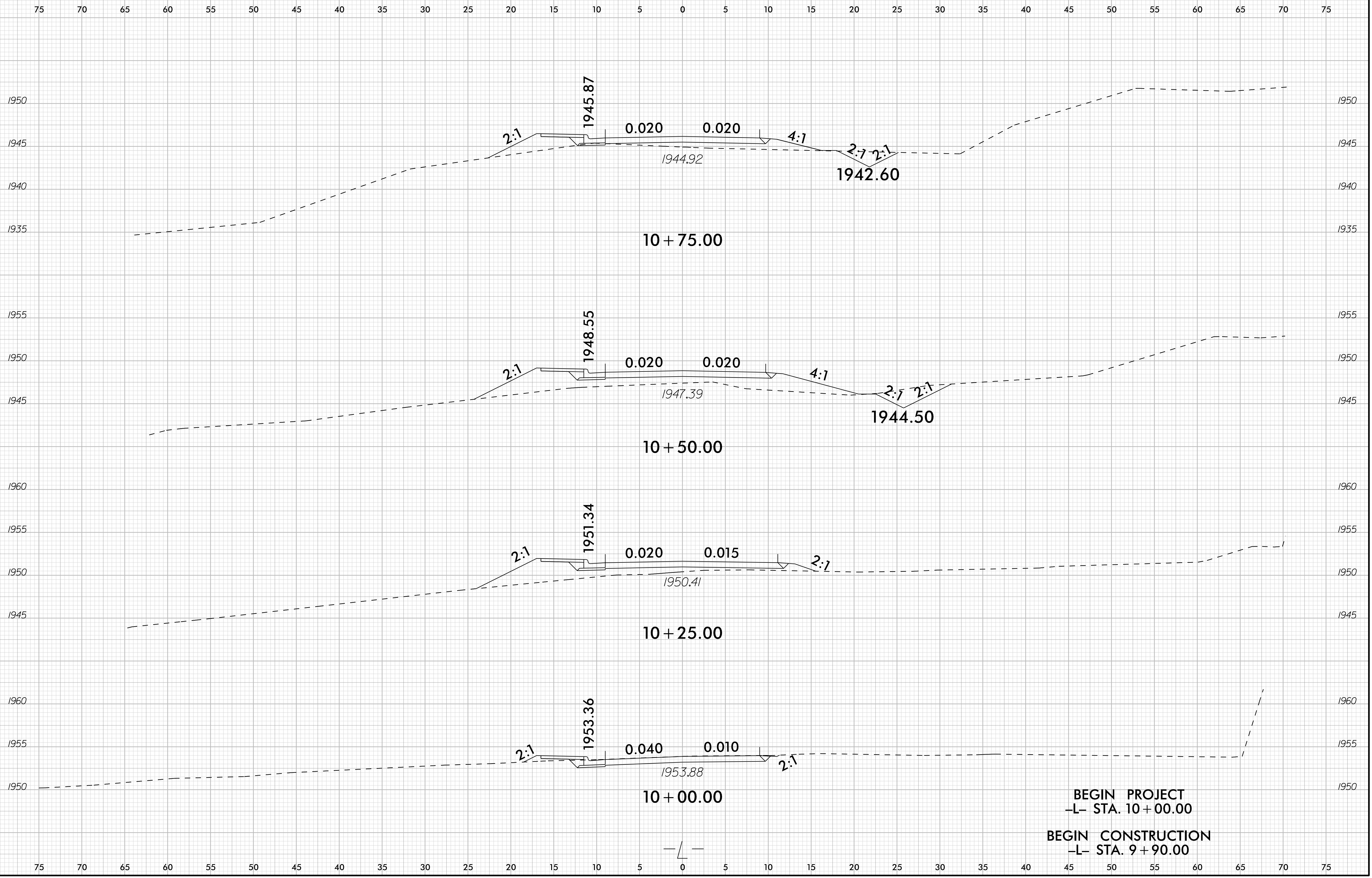

BEGIN PROJECT
 -L- STA. 10 + 00.00

BEGIN CONSTRUCTION
 -L- STA. 9 + 90.00

5/3/2022
 C:\pwworking\gfpw01\white\1311741\Sweir.rdy.xpl.dgn
 Bwhite

6/23/16

	PROJ. REFERENCE NO.	SHEET NO.
	48786	X-2

75 70 65 60 55 50 45 40 35 30 25 20 15 10 5 0 5 10 15 20 25 30 35 40 45 50 55 60 65 70 75

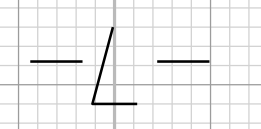
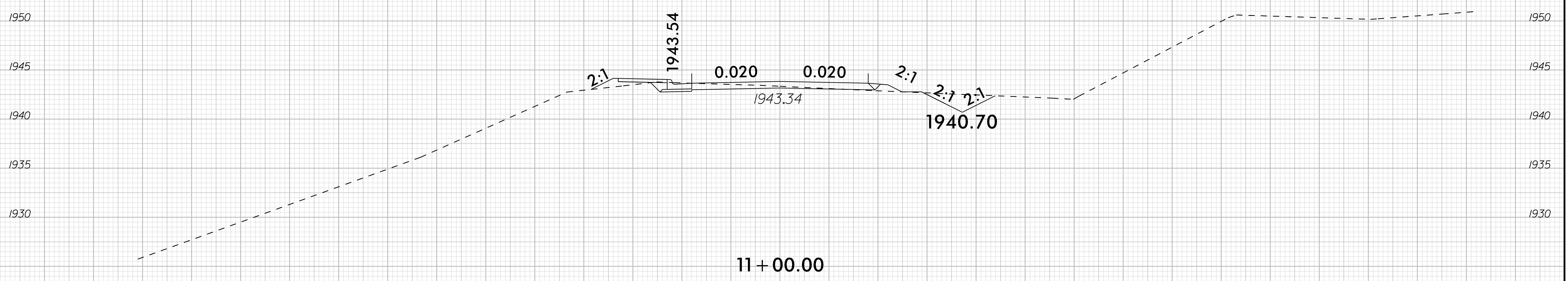
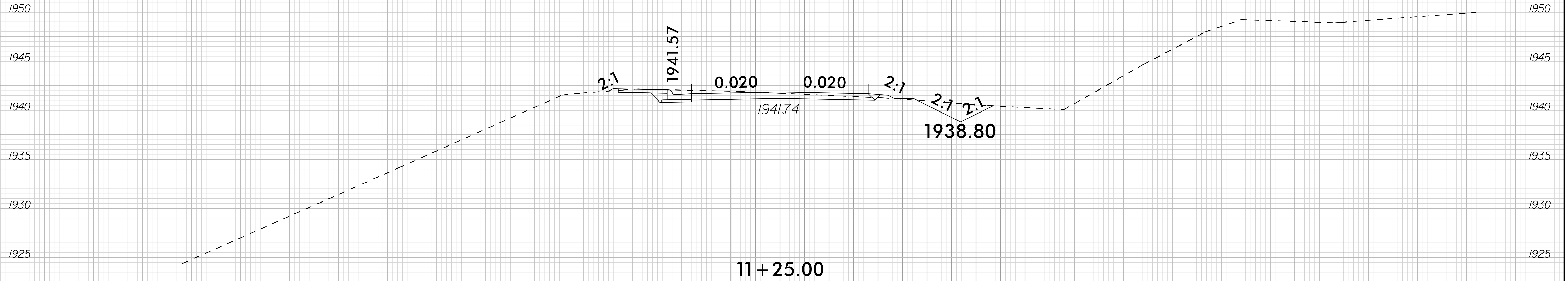

75 70 65 60 55 50 45 40 35 30 25 20 15 10 5 0 5 10 15 20 25 30 35 40 45 50 55 60 65 70 75

5/3/2022
C:\work\king\gfpw01\white\1311741\Stain_rdy_xpl.dgn
Bwhite

6/23/16

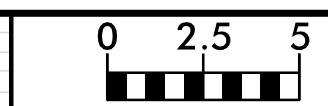

PROJ. REFERENCE NO.	SHEET NO.
48786	X-3

75 70 65 60 55 50 45 40 35 30 25 20 15 10 5 0 5 10 15 20 25 30 35 40 45 50 55 60 65 70 75

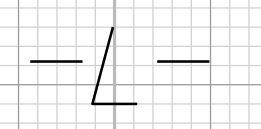
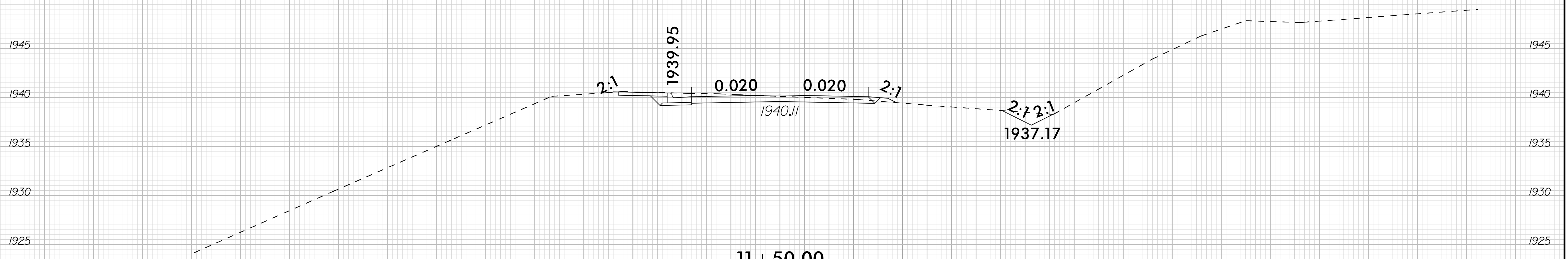
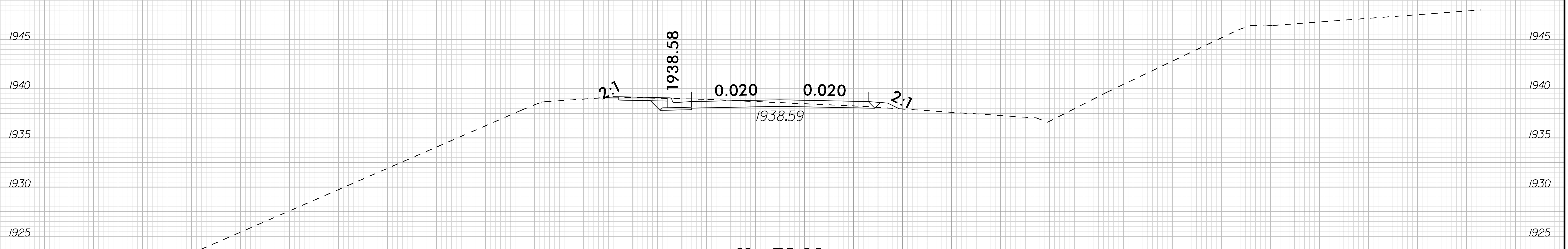

5/3/2022
 C:\work\king\gfpw01\white\1311741\Swain_rdy_xpl.dgn
 Bwhite

75 70 65 60 55 50 45 40 35 30 25 20 15 10 5 0 5 10 15 20 25 30 35 40 45 50 55 60 65 70 75

6/23/16

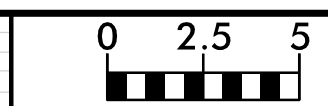

PROJ. REFERENCE NO.	SHEET NO.
48786	X-4

75 70 65 60 55 50 45 40 35 30 25 20 15 10 5 0 5 10 15 20 25 30 35 40 45 50 55 60 65 70 75

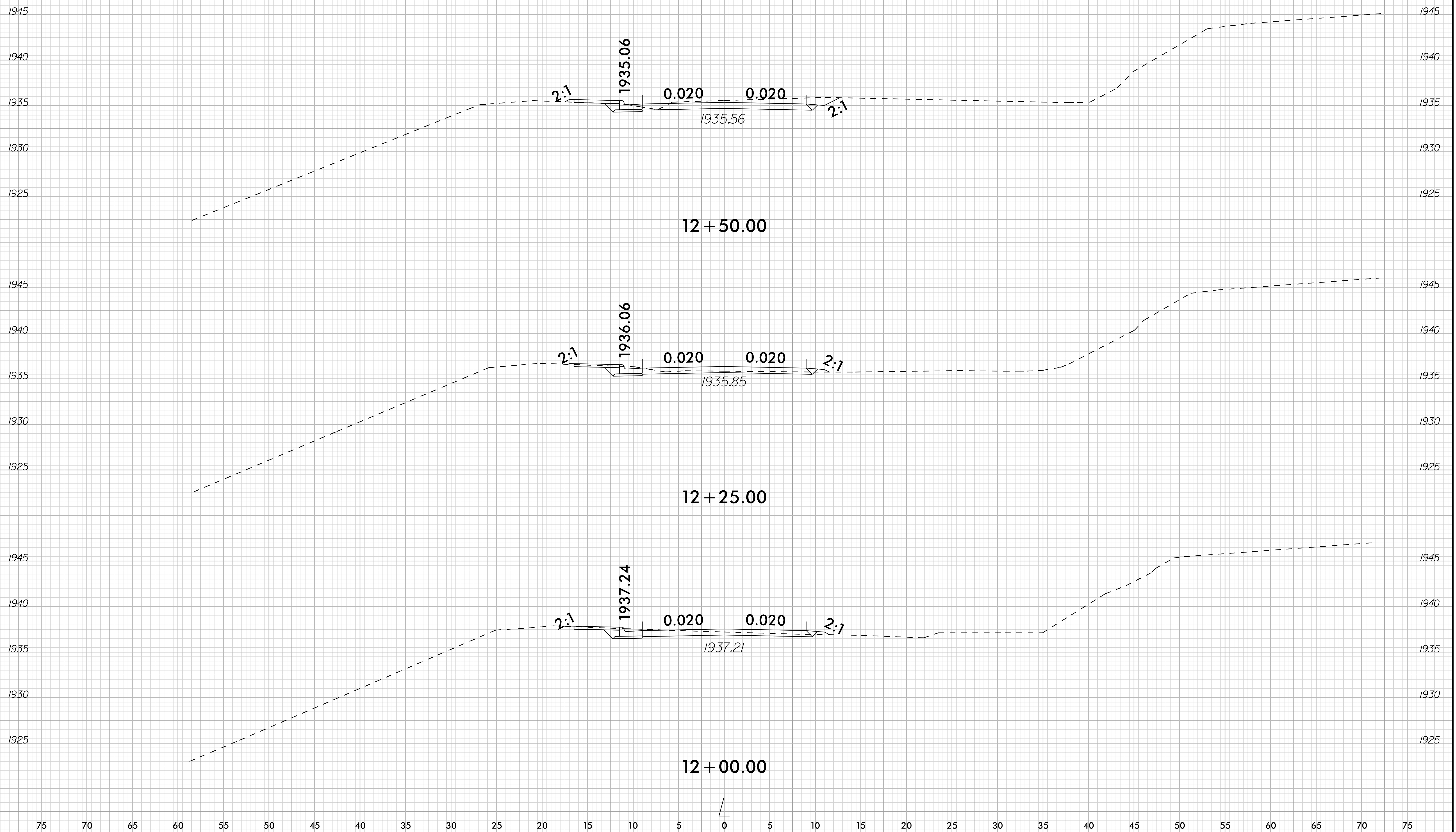

5/3/2022
C:\work\king\gfpw01\white\1311741\Swain_rdy_xpl.dgn
Bwhite

75 70 65 60 55 50 45 40 35 30 25 20 15 10 5 0 5 10 15 20 25 30 35 40 45 50 55 60 65 70 75

6/23/16

	PROJ. REFERENCE NO.	SHEET NO.
	48786	X-5

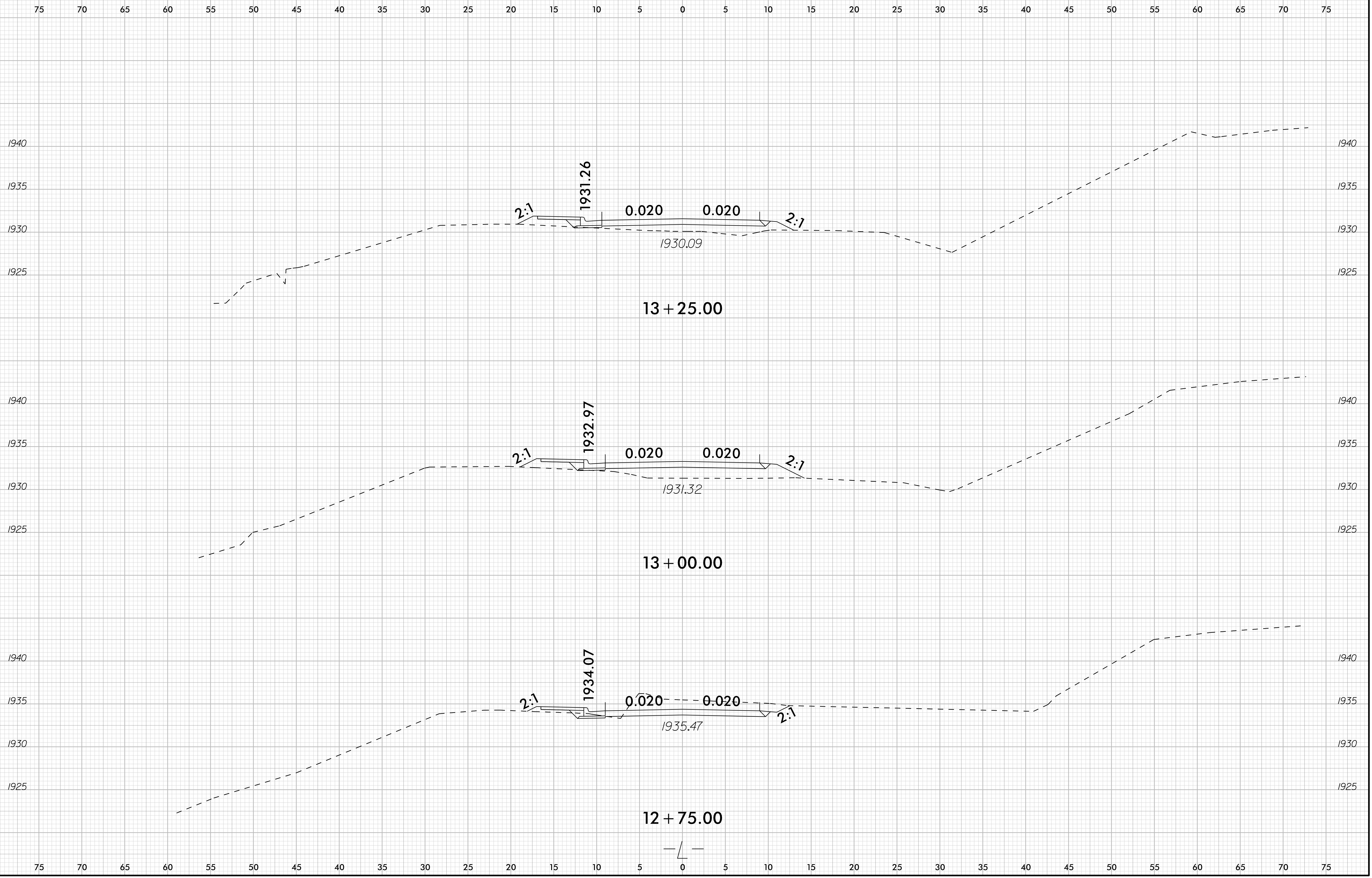

5/3/2022
C:\pwworking\gfpw01\white\1311741\Swept.dwg_xpl.dgn
Bwhite

6/23/16

0 2.5 5	PROJ. REFERENCE NO.	SHEET NO.
	48786	X-6

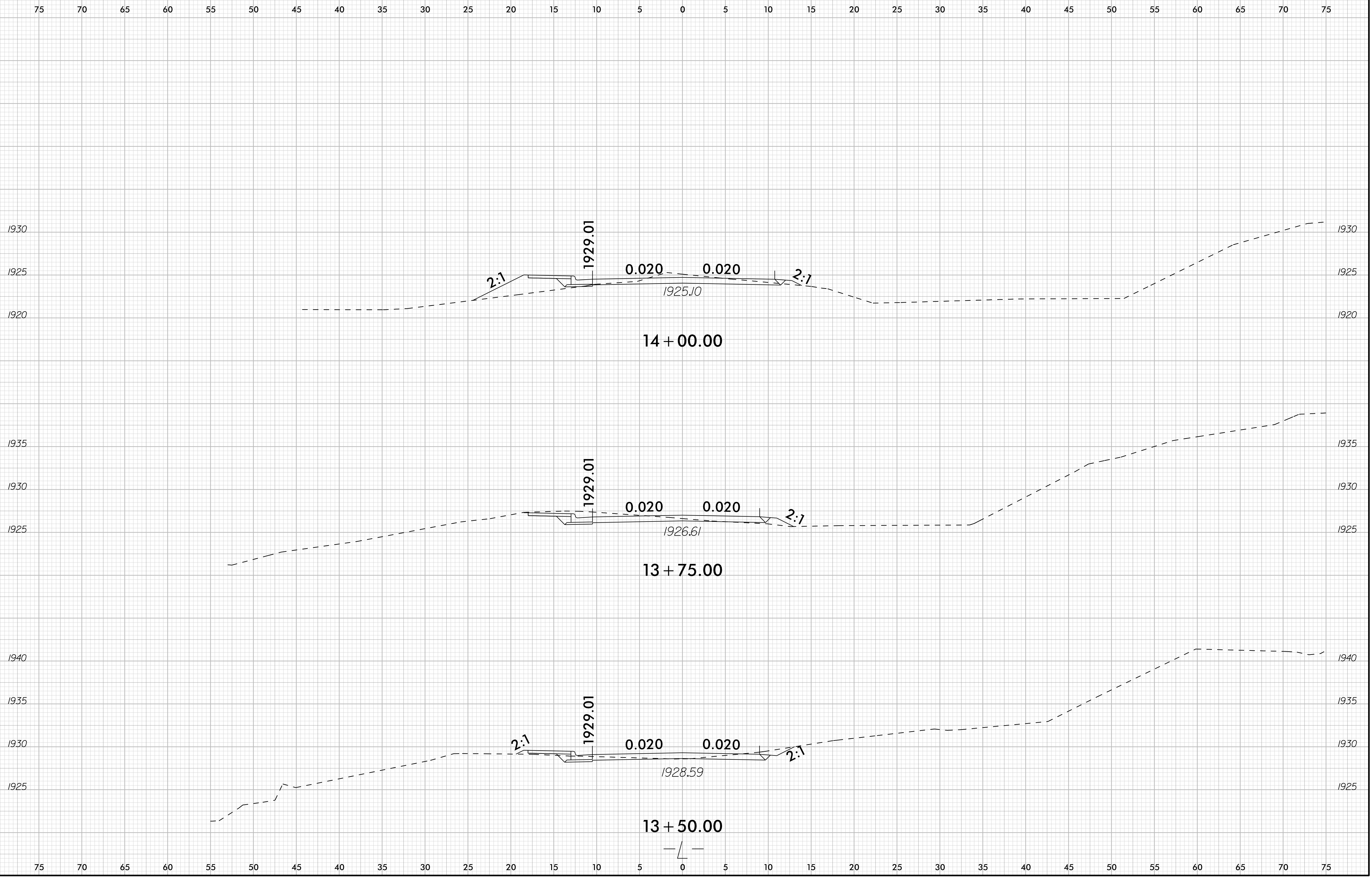

5/3/2022
C:\pwworking\gfpw01\white\1311741\Sweir.rdy.xpl.dgn
Bwhite

6/23/16

	PROJ. REFERENCE NO.	SHEET NO.
	48786	X-7

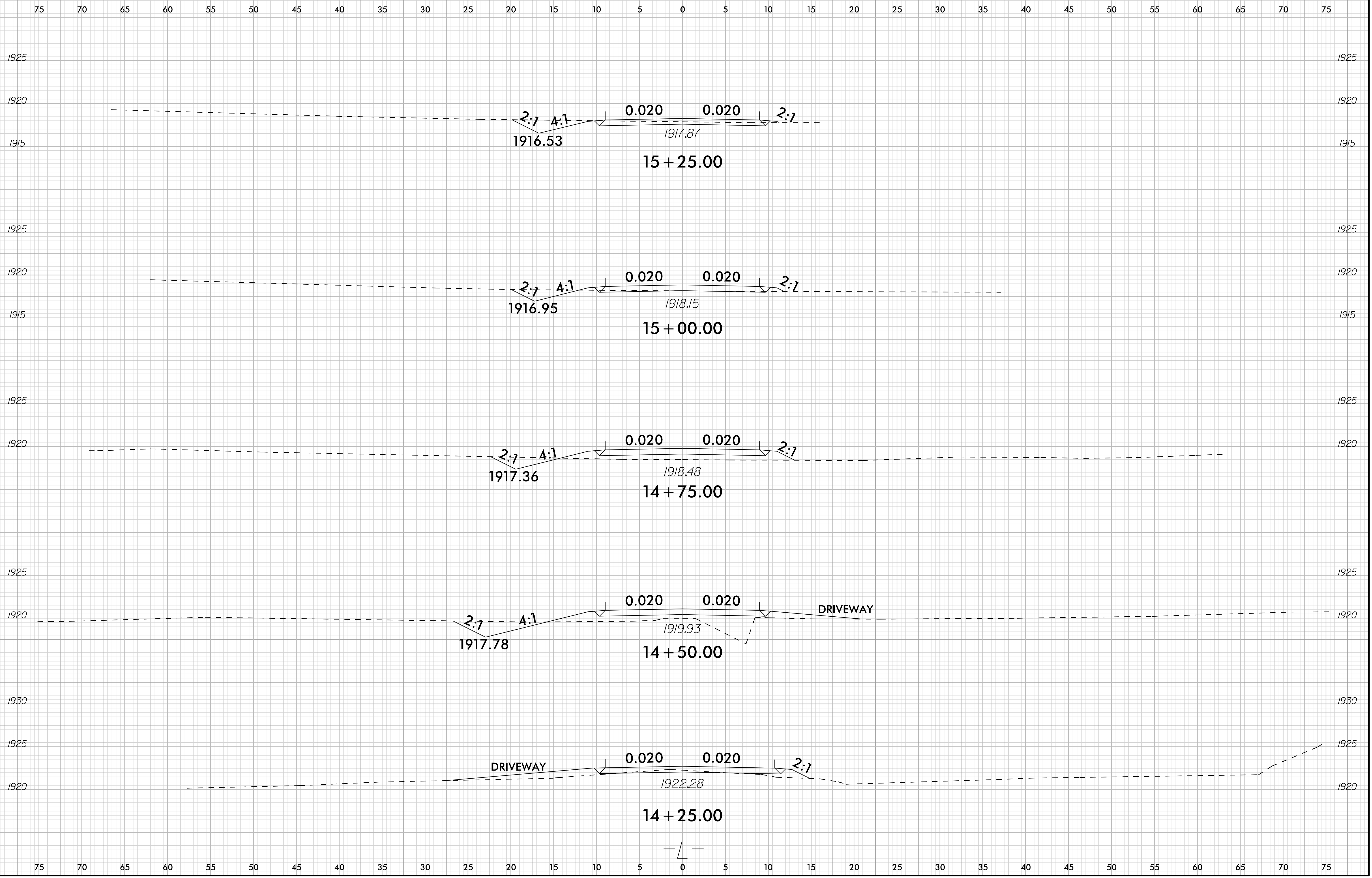

5/3/2022
C:\working\gfpw01\white\1311741\Swain_rdy_xpl.dgn
Bwhite

6/23/16

0 2.5 5	PROJ. REFERENCE NO.	SHEET NO.
	48786	X-8

75 70 65 60 55 50 45 40 35 30 25 20 15 10 5 0 5 10 15 20 25 30 35 40 45 50 55 60 65 70 75

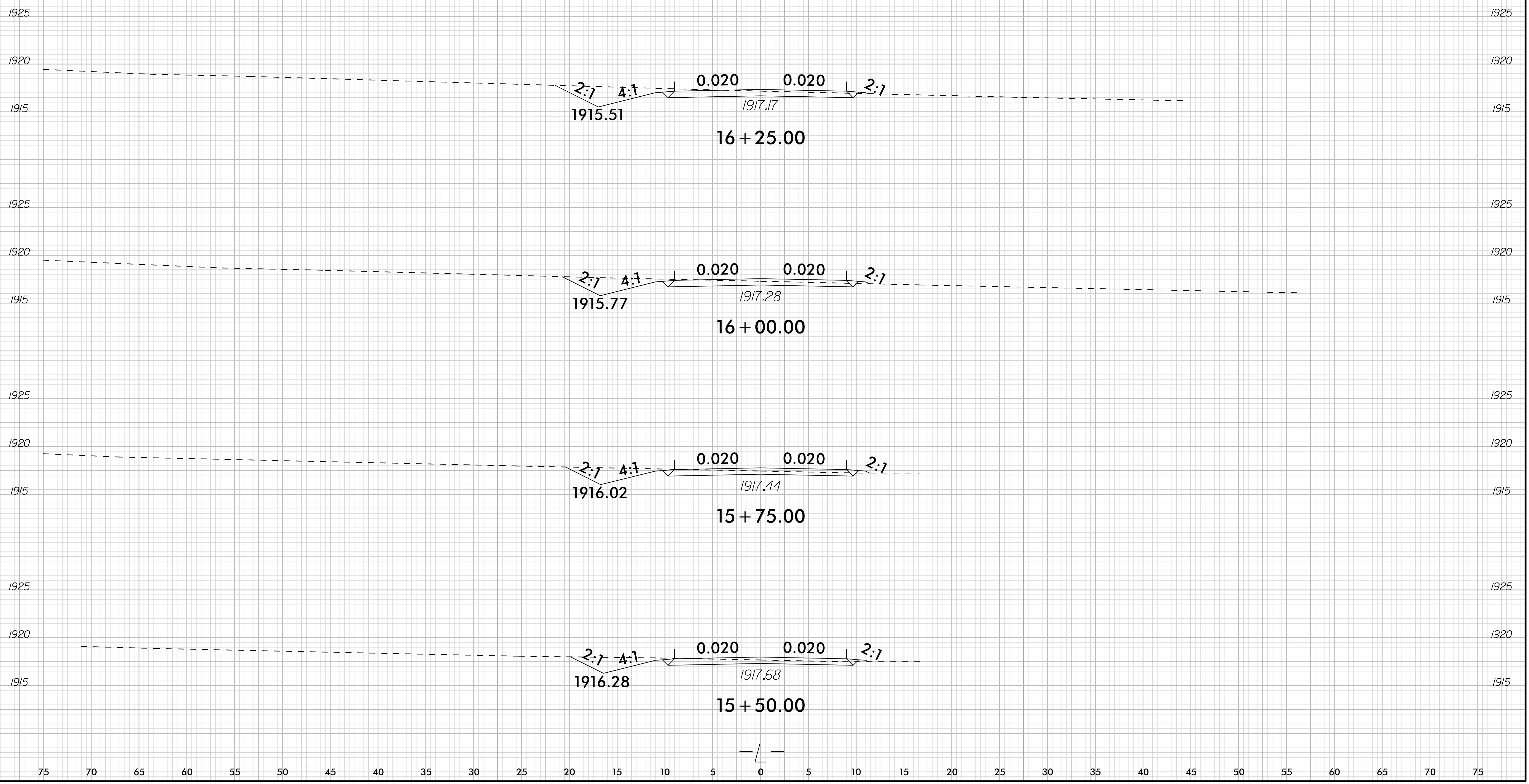

5/3/2022
 C:\pwworking\gfpw01\white\1311741\Sweir.rdy.xpl.dgn
 Bwhite

75 70 65 60 55 50 45 40 35 30 25 20 15 10 5 0 5 10 15 20 25 30 35 40 45 50 55 60 65 70 75

6/23/16

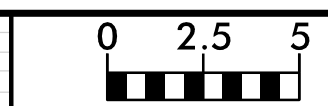

PROJ. REFERENCE NO.	SHEET NO.
48786	X-9

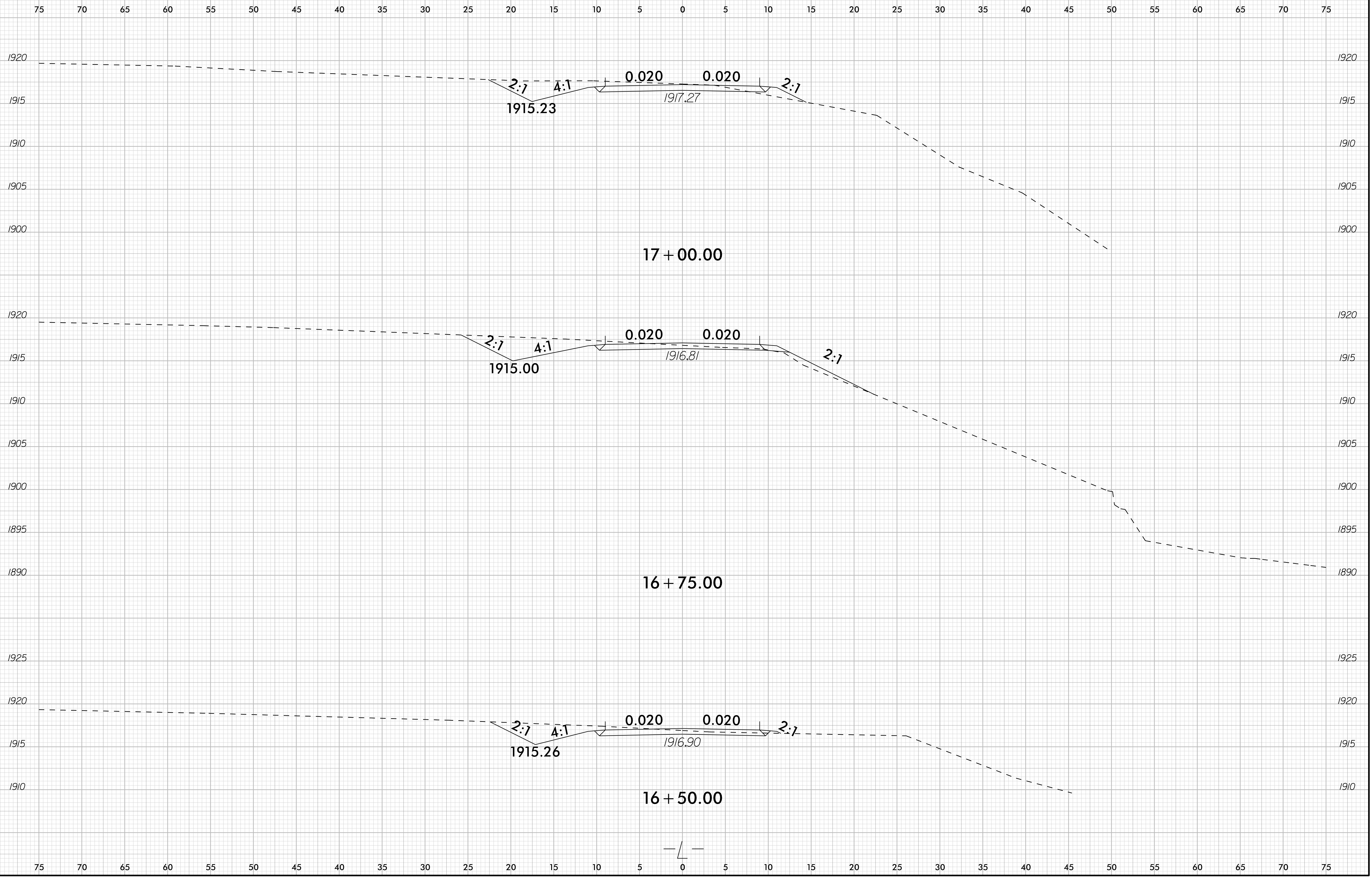

5/3/2022
C:\work\king\gfpw01\white\1311741\Swein.rdy.xpl.dgn
Bwhite

6/23/16

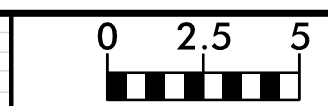

PROJ. REFERENCE NO.	SHEET NO.
48786	X-10

75 70 65 60 55 50 45 40 35 30 25 20 15 10 5 0 5 10 15 20 25 30 35 40 45 50 55 60 65 70 75

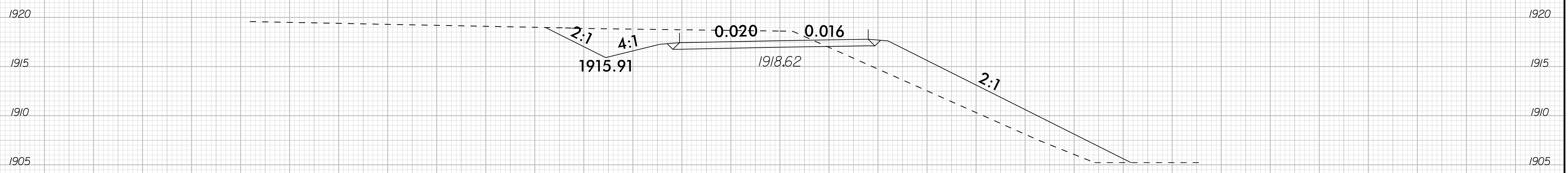

17 + 75.00

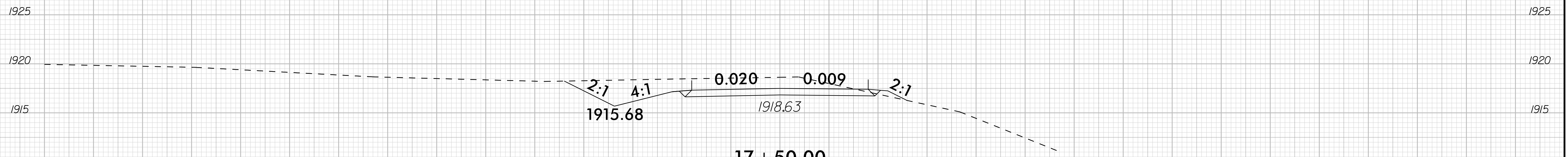

17 + 50.00

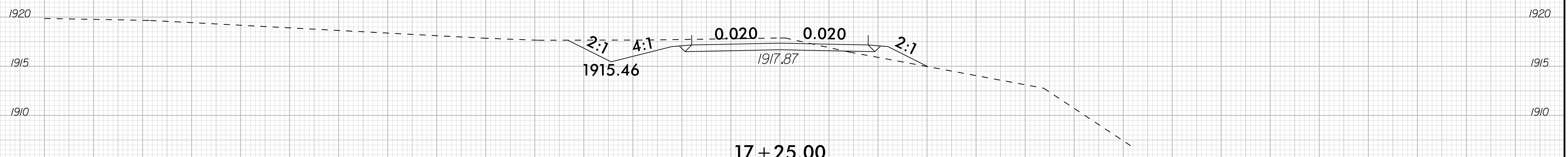

17 + 25.00

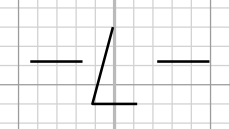

75 70 65 60 55 50 45 40 35 30 25 20 15 10 5 0 5 10 15 20 25 30 35 40 45 50 55 60 65 70 75

5/3/2022
C:\working\gfpw01\white\1311741\Swept.dwg
Bwhite

6/23/16

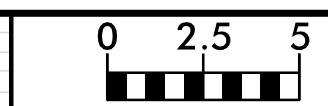

PROJ. REFERENCE NO.	SHEET NO.
48786	X-11

75 70 65 60 55 50 45 40 35 30 25 20 15 10 5 0 5 10 15 20 25 30 35 40 45 50 55 60 65 70 75

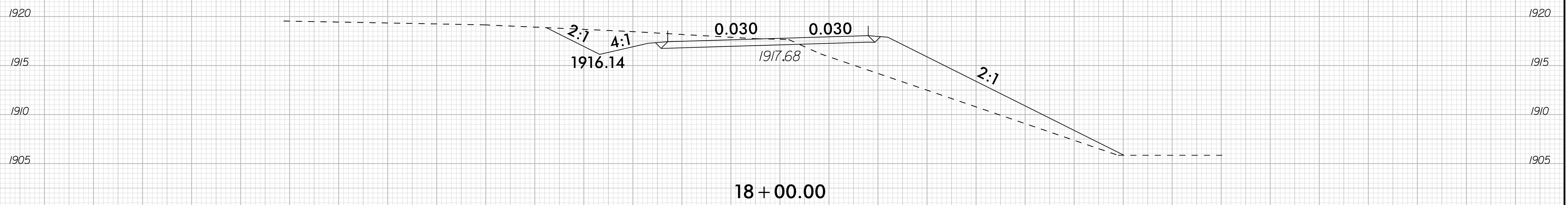
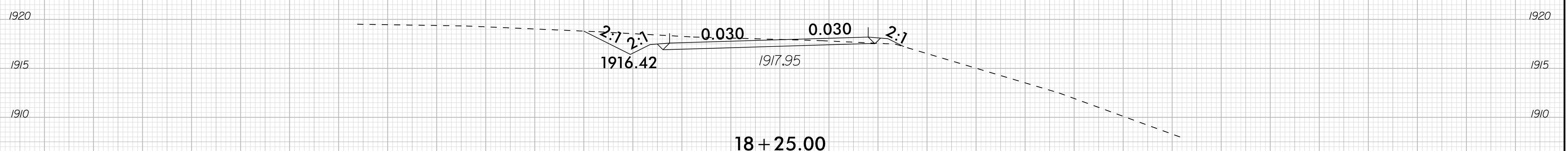
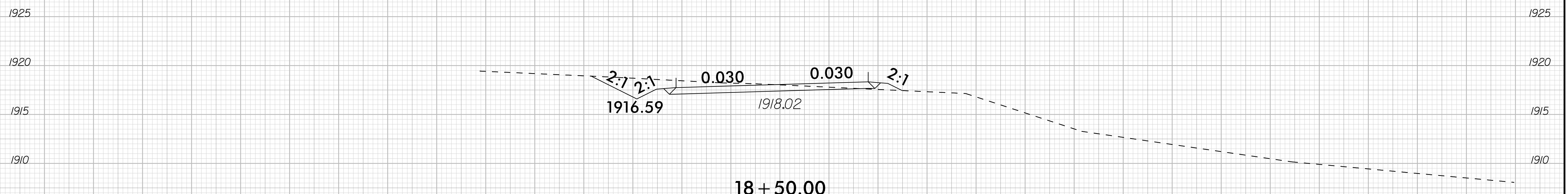

75 70 65 60 55 50 45 40 35 30 25 20 15 10 5 0 5 10 15 20 25 30 35 40 45 50 55 60 65 70 75

5/3/2022
C:\pwworking\gfpw01\white\1311741\Sweir.rdy.xpl.dgn
Bwhite

6/23/16

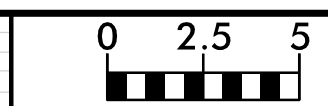

PROJ. REFERENCE NO.	SHEET NO.
48786	X-12

75 70 65 60 55 50 45 40 35 30 25 20 15 10 5 0 5 10 15 20 25 30 35 40 45 50 55 60 65 70 75

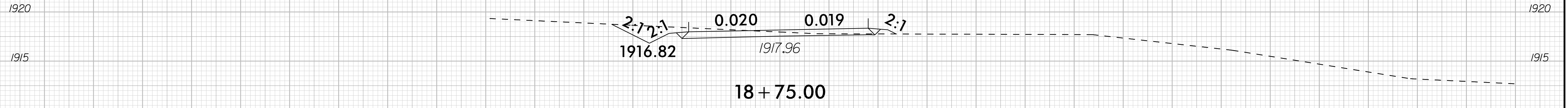
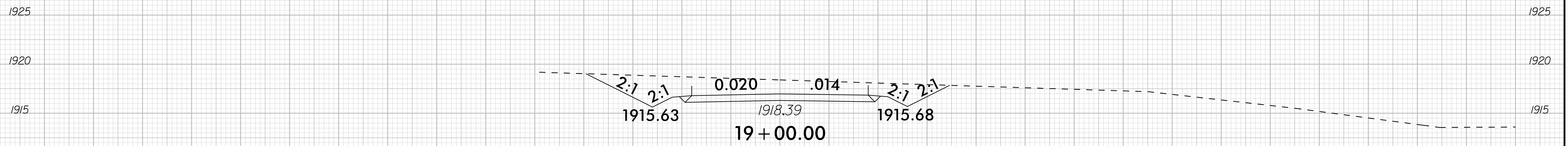
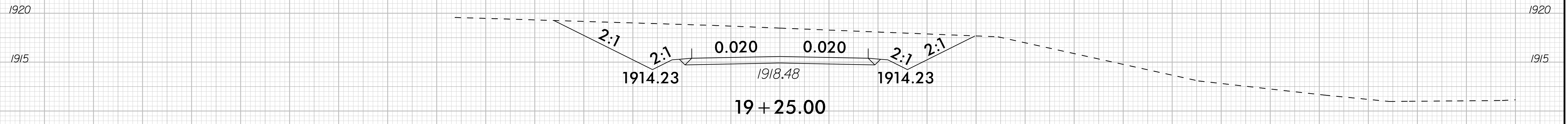
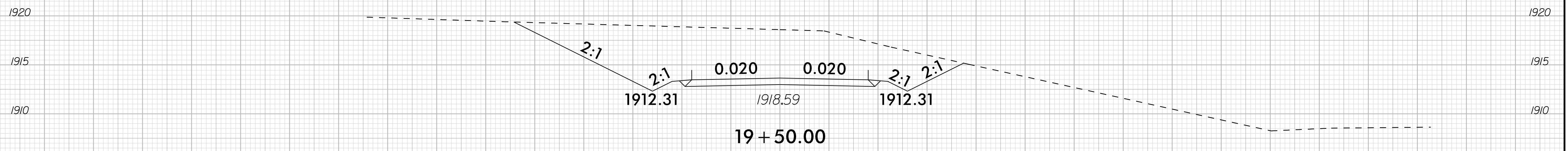

75 70 65 60 55 50 45 40 35 30 25 20 15 10 5 0 5 10 15 20 25 30 35 40 45 50 55 60 65 70 75

5/3/2022
C:\working\gfpw01\white\1311741\Swain_rdy_xpl.dgn
Bwhite

6/23/16

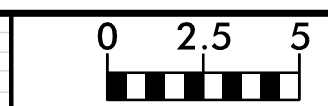

PROJ. REFERENCE NO.	SHEET NO.
48786	X-13

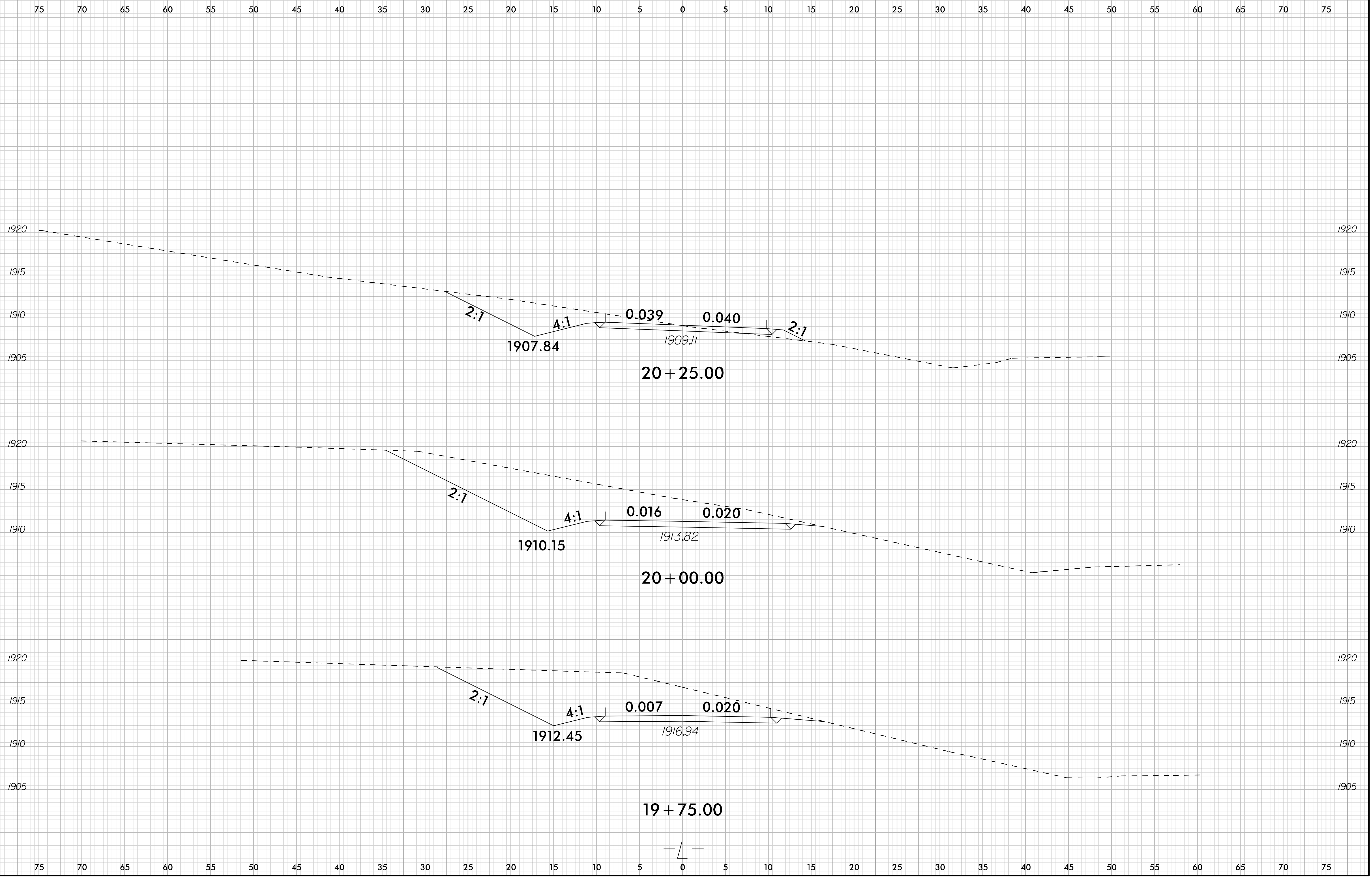

5/3/2022
C:\work\king\gfpw01\white\1311741\Swept.dwg_xpl.dgn
Bwhite

6/23/16

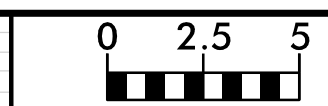

PROJ. REFERENCE NO.	SHEET NO.
48786	X-14

75 70 65 60 55 50 45 40 35 30 25 20 15 10 5 0 5 10 15 20 25 30 35 40 45 50 55 60 65 70 75

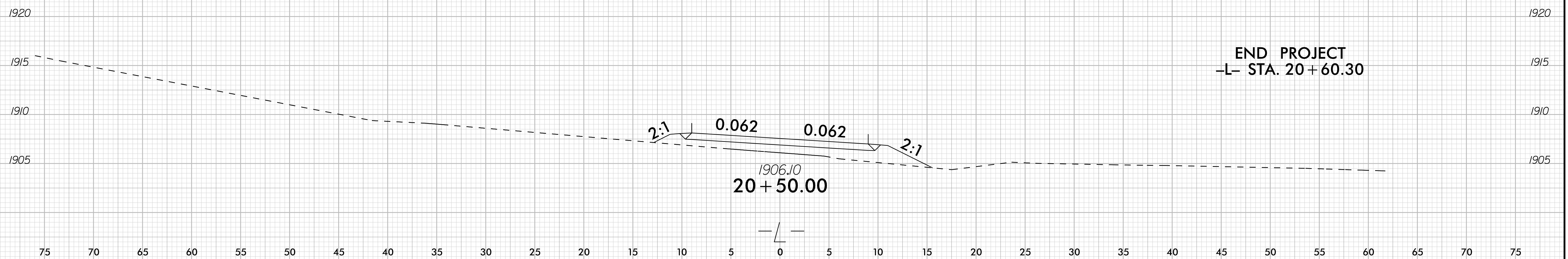

5/3/2022
C:\working\gfpw01\white\1311741\Swept.dwg xpl.dgn
Bwhite